

# INSTALLATION MANUAL FOR ROOM AIR CONDITIONER

## (Split Wall-Mounted Type)

### INSTALLATION PRECAUTIONS

- Please read this installation manual carefully before operating the unit to ensure correct installation.
- If the power cord is damaged, replacement work shall be performed by authorised personnel only.
- Installation must be performed in accordance with the requirement of NEC and CEC by authorized personnel only.
- Contact an authorized service technician for repair, maintenance and installation of this unit.
- This appliance is not intended for use by persons (including children) with reduced physical, sensory or mental capabilities, or lack of experience and knowledge, unless they have been given supervision or instruction concerning use of the appliance by persons responsible for their safety.
- Children should be supervised to ensure that they do not play with the appliance.
- All the pictures in the instructions are for explanation purposes only. The actual shape should prevail.
- The design and specifications are subject to change without prior notice for product improvement. Consult with the sales agency or manufacturer for details.

### SAFETY PRECAUTIONS

- Please read these safety precautions carefully before installation.
- Be sure to follow all the precautions below, they are all important for ensuring safety.

	<b>WARNING</b>	This symbol indicates the possibility of death or serious injury.
	<b>CAUTION</b>	This symbol indicates the possibility of injury or damage to property.

#### WARNING

- 1) Install according to this installation instructions strictly. If installation is defective, it will cause water leakage, electrical shock, or fire.
- 2) Use the included accessories parts and specified parts for installation. otherwise, it will cause the set to fall, water leakage, electrical shock fire.
- 3) Install at a strong and firm location which is able to withstand the set's weight. If the strength is not enough or installation is not properly done, the set will drop and cause injury.
- 4) For electrical work, follow the local national wiring standard, regulation and this installation instructions. An independent circuit and single outlet must be used. If electrical circuit capacity is not enough or defect found in electrical work, it will cause electrical shock fire.
- 5) Use the specified cable and connect tightly and clamp the cable so that no external force will be acted on the terminal. If connection or fixing is not perfect, it will cause heat-up or fire at the connection.
- 6) Wiring routing must be properly arranged so that control board cover is fixed properly. If control board cover is not fixed perfectly, it will overheat at connection point of terminal, fire or electrical shock.
- 7) When carrying out piping connection, take care not to let air substances other than the specified refrigerant go into refrigeration cycle. Otherwise, it will cause lower capacity, abnormal high pressure in the refrigeration cycle, explosion and injury.
- 8) Do not modify the length of the power supply cord or use of extension cord, and do not share the single outlet with other electrical appliances. Otherwise, it will cause fire or electrical shock.

#### CAUTION

- 1) This equipment must be grounded and installed with ground leakage current breaker. It may cause electrical shock if grounding is not perfect.
- 2) Do not install the unit at place where leakage of flammable gas may occur. In case gas leaks and accumulates at surrounding of the unit, it may cause fire.
- 3) Carry out drainage piping as mentioned in installation instructions. If drainage is not perfect, water may enter the room and damage the furniture.

### SELECT THE BEST LOCATION

#### Indoor unit

- There should not be any heat source or stream near the unit.
- There should not be any obstacles blocking the air circulation.
- A place where air circulation in the room is good.
- A place where drainage can be easily done.
- A place where noise prevention is taken into consideration.
- Do not install the unit near the door way.
- Ensure the spaces indicated by arrows from the wall, ceiling, fence or other obstacles.
- There should not be any direct sunlight. If unavoidable, sunlight prevention should be taken into consideration.

#### Outdoor unit

- If an awning is built over the unit to prevent direct sunlight or rain, be careful that heat radiation from the condenser is not obstructed.
- There should not be any animal or plant which could be affected by hot air discharged.
- Keep the spaces indicated by arrow from wall ceiling, fence or other obstacles.
- Do not place any obstacles which may cause a short circuit of the discharged air.

#### Settlement of outdoor unit

- Anchor the outdoor unit with a bolt and nut  $\phi 10$  or  $\phi 8$  tightly and horizontally on a concrete or rigid mount.
- NOTE:** The outdoor unit you purchase may be like one of the following. Install the outdoor unit according to the dimension as indicated in the table below:

Outdoor unit dimension mm (WxHxD)	Mounting dimensions	
	A (mm)	B (mm)
670x540x265	481	276
780x540x250	549	276
760x590x285	530	290
845x700x320	560	335
900x860x315	590	333

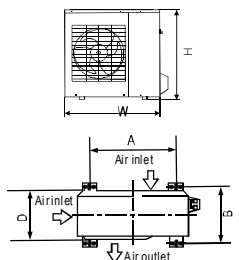

### ACCESSORIES

Number	Name of Accessories	Qty	
1	Installation Plate	1	
2	Clip Anchor	5-8 (depending on models)	
3	Self-tapping Screw AST3.9x25	5-8 (depending on models)	
4	Seal (For cooling & heating models only)	1	
5	Drain Joint (For cooling & heating models only)	1	
6	Connecting pipe Assembly	Parts you must purchase. The pipe size differ from appliance to appliance. Consult the technician for the proper size.	
	Liquid side		$\phi 6.35$ $\phi 9.52$ $\phi 9.52$
	Gasside		$\phi 12.7$ $\phi 16$
7	Remote controller	1	
8	Self-tapping Screw B ST2.9x10	optional parts 2	
9	Remote controller holder	1	
10	Air freshening filter (installed on Air filter)	1	

**NOTE:** Except the above parts provided, the other parts needed during installation you must purchase.

## 1 INSTALLATION PLATE MOUNTING

#### NOTE:

The mounting wall is strong and solid enough to prevent it from the vibration.

#### Installation Plate Mounting

1. Fit the installation plate horizontally on structural parts of the wall with spaces around the installation plate.
2. If the wall is made of brick, concrete or the like, drill five or eight 5mm diameter holes in the wall. Insert clip anchor for appropriate mounting screws.
3. Fit the installation plate on the wall with five or eight type A screws.

#### NOTE:

Mount the Installation Plate and drill holes in the wall according to the wall structure and corresponding mounting points on the installation plate. The installation plate provided with the machine differ from appliance to appliance. (Dimensions are in "mm" unless otherwise stated)

Correct orientation of Installation Plate

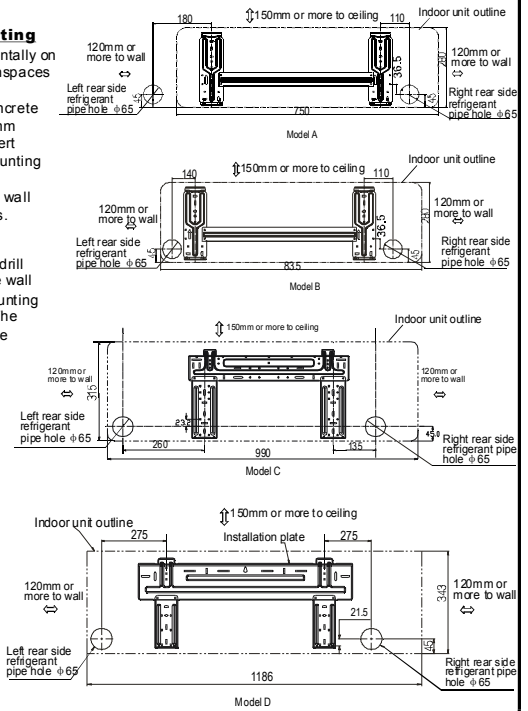
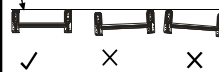

## 2 DRILL A HOLE IN THE WALL

1. Determine hole positions according to left and right side of the installation plate. The hole center is obtained by measuring the distance as shown in the diagram above.
2. Drill the piping hole with  $\phi 65$ mm hole-core drill.
3. Drill the piping hole at either the right or the left and the hole should be slightly slanted to the outdoor side.
4. Always take steps to protect the pipe when drilling metal grid, metal plate or the like.

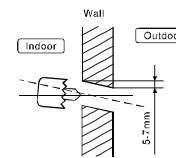

## 3 CONNECT THE CABLE TO THE INDOOR UNIT

#### Electrical work

Electric safety regulations for the initial installation

1. If there is serious safety problem about the power supply, the technicians should refuse to install the air conditioner and explain to the client until the problem is solved.
2. Power voltage should be in the range of 90%~110% of rated voltage.
3. The surge protector and main power switch with a 1.5 times capacity of Max. Current of the unit should be installed in power circuit.
4. Ensure the air conditioner is grounded well.
5. According to the attached Electrical Connection Diagram located on the panel of the outdoor unit to connect the wire.
6. All wiring must comply with local and national electrical codes and be installed by qualified and skilled electricians.
7. An all-pole disconnection device which has at least 3mm separation distance in all pole and a residual current device (RCD) with the rating of not exceeding 30mA shall be incorporated in the fixed wiring according to the national rule.
8. An individual branch circuit and single receptacle used only for this air conditioner must be available. See the following table for suggested wire sizes and fuse specifications:

Suggest Minimum Wire Size (AWG: American Wire Gauge):

Appliance Amps	AWG Wire Size
10	18
13	16
18	14
25	12
30	10

#### NOTE:

The cable size and the current of the fuse or switch are determined by the maximum current indicated on the nameplate which located on the side panel of the unit. Please refer to the nameplate before selecting the cable, fuse and switch.

#### Connect the cable to the indoor unit

1. The inside and outside connecting cable can be connected without removing the front grille.
2. The indoor power cord type is H05VV-F or H05V2V-F, the outdoor power cord and inter-connected cord type is H07RN-F.
3. Lift the indoor unit panel up, remove the electrical box cover by loosening the screw.
4. Ensure the colour of wires of outdoor unit and the terminal Nos. are the same to the indoor's respectively.
5. Wrap those cables not connected with terminals with insulation tapes, so that they will not touch any electrical components. Secure the cable onto the control board with the cord clamp.

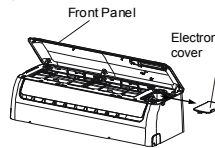

#### Terminal block of indoor unit

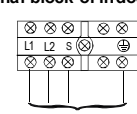

To outdoor unit

## 4 CONNECTIVE PIPE AND DRAINAGE INSTALLATION

#### Drainage

1. Run the drain hose sloping downward. Do not install the drain hose as illustrated in wrong figures.
2. When connecting extension drain hose, insulate the connecting part of extension drain hose with a shield pipe, do not let the drain hose slack.

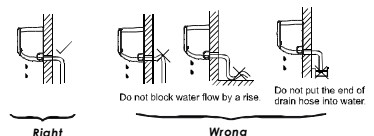

INDOOR UNIT

### Connective pipe installation

- For the left-hand and right-hand piping, remove the pipe cover from the side panel.
- For the right back and left back piping, install the piping as shown.  
**NOTE:** For 9K/12K model, there is only one side drainage structure design. For >18K model, one side drainage structure is standard. Both sides drainage structure is optional and can only be customized from factory. For both sides drainage structure, it can be chosen for right, left or both sides drainage connection. If choosing both sides drainage connection, another proper drain hose is needed as there is only one drain hose offered by factory. If choosing one side drainage connection, make sure the drain hole on the other side is well plugged. The connection of the drain hose is supposed to be done by qualified installer in case of water leakage.
- Bundle the tubing, connecting cable, and drain hose with tape securely, evenly as shown in Figure on the right.
- Because the condensed water from rear of the indoor unit is gathered in ponding box and is piped out of room. Do not put anything else in the box.

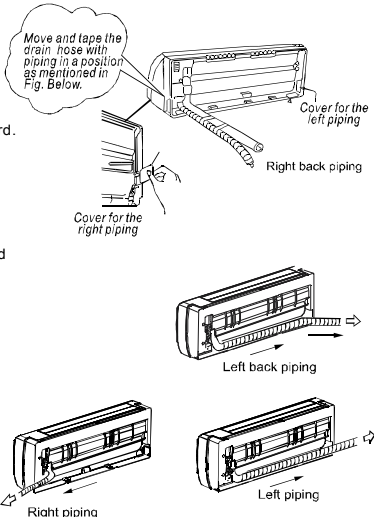

#### CAUTION

- Connect the indoor unit first, then the outdoor unit.
- Do not allow the piping to let out from the back of the indoor unit.
- Be careful not to let the drain hose slack.
- Heat insulation should be done to the extension drain hose of indoor unit.
- Be sure that the drain hose is located at the lowest side of the bundle. Locating at the upper side can cause drain pan to overflow inside the unit.
- Never intercross nor intertwist the power wire with any other wiring.

#### Indoor unit installation

- Pass the piping through the hole in the wall.
- Hook the indoor unit onto the upper portion of installation plate (Engage the indoor unit with the upper edge of the installation plate). Ensure the hooks are properly seated on the installation plate by moving it in left and right.
- Piping can easily be made by lifting the indoor unit with a cushioning material between the indoor unit and the wall. Get it out after finish piping.
- Press the lower left and right side of the unit against the installation plate until hooks engages with their slots.

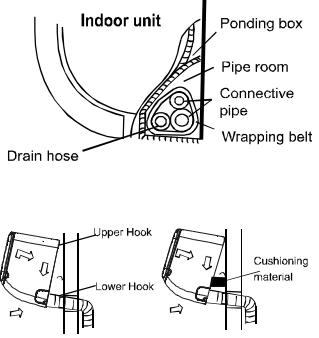

## 4 CONNECT THE CABLE TO THE OUTDOOR UNIT

- Remove the electrical control board cover from the outdoor unit by loosening the screw.
- Connect the connective cables to the terminals as identified with their respective matched numbers on the terminal block of indoor and outdoor units.
- Secure the cable onto the control board with the cord clamp.
- To prevent the ingress of water, form a loop of the connective cable as illustrated in the installation diagram of indoor and outdoor units.
- Insulate unused cords (conductors) with PVC-tape. Process them so they do not touch any electrical or metal parts.

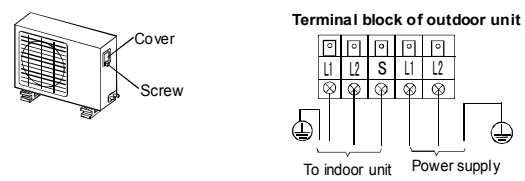

## 5 AIR PURGING AND TEST OPERATION

### 1. Airpurging

- The indoor unit and tubing between the indoor and outdoor unit must be leak tested and evacuated to remove any noncondensables and moisture from the system.
- Check that each tube (both liquid and gas side tubes) between the indoor and outdoor units have been properly connected and all wiring for the test run has been completed.
- Pipe length and refrigerant amount:

Connective pipe length	Air purging method	Additional amount of refrigerant to be charged	
Less than 7.5m	Use vacuum pump	---	
More than 7.5m	Use vacuum pump	Liquid side: $\phi$ 6.35mm R22: (Pipe length-7.5)x30g/m R410A: (Pipe length-7.5)x20g/m	Liquid side: $\phi$ 9.52mm R22: (Pipe length-7.5)x60g/m R410A: (Pipe length-7.5)x40g/m

- For the R410A refrigerant model, make sure the refrigerant added into air conditioner is liquid form in any cases.
- When relocating the unit to another place, using vacuum pump to perform evacuation.

#### CAUTION

- Open the valve stem until it hits against the stopper. Do not try to open it further.
- Securely tighten the valve stem cap with a spanner or the like.
- Valve stem cap tightening torque. See Tightening torque table.

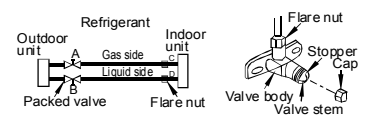

## 1 OUTDOOR INSTALLATION PRECAUTION

- Install the outdoor unit on a rigid base to prevent increasing noise level and vibration.
- Determine the air outlet direction where the discharged air is not blocked.
- In the case that the installation place is exposed to strong wind such as a sea side, make sure the fan operating properly by putting the unit lengthwise along the wall or using a dust or shield plates.
- Specially in windy area, install the unit to prevent the admission of wind. If need suspending installation, the installation bracket should accord with technique requirement in the installation bracket diagram. The installation wall should be solid brick, concrete or the same intensity construction, or actions to reinforce, damping supporting should be taken.
- The connection between bracket and wall, bracket and the air conditioner should be firm, stable and reliable.
- Be sure there is no obstacle which block radiating air.

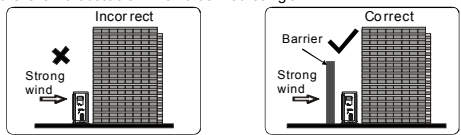

## 2 DRAIN JOINT INSTALLATION

- NOTE:** The drain joint is slightly different according to the different outdoor unit.
- For the drain joint with the seal (Fig. A), first fit the seal onto the drain joint, then insert the drain joint into the base pan hole of outdoor unit, rotate 90° to securely assemble them. To install drain joint as shown in Fig. B, insert the drain joint into the base pan hole of outdoor unit until it remains fixed with a clicking sound. Connecting the drain joint with an extension drain hose (Locally purchased), in case of the water draining off the outdoor unit during the heating mode.

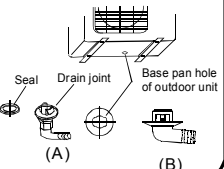

## 3 REFRIGERANT PIPE CONNECTION

- Flaring**
- Cut a pipe with a pipe cutter.
  - Put flare nuts on pipe/tube having completed burr removal and flare the pipe.
  - Firmly hold copper pipe in a die in the dimension shown in the table below.

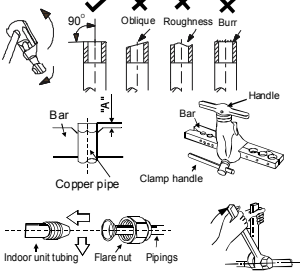

Outer diam. (mm)	A(mm)	
	Max.	Min.
$\phi$ 6.35	1.3	0.7
$\phi$ 9.52	1.6	1.0
$\phi$ 12.7	1.8	1.0
$\phi$ 16	2.2	2.0

#### Tightening connection

- Align pipes to be connected.
- Sufficiently tighten the flare nut with fingers, and then tighten it with a spanner and torque wrench as shown.
- Excessive torque can break nut depending on installation conditions.

Outer diam.	Tightening torque(N.cm)	Additional tightening torque(N.cm)
$\phi$ 6.35mm	1500 (153kgf.cm)	1600 (163kgf.cm)
$\phi$ 9.52mm	2500 (255kgf.cm)	2600 (265kgf.cm)
$\phi$ 12.7mm	3500 (357kgf.cm)	3600 (367kgf.cm)
$\phi$ 16mm	4500 (459kgf.cm)	4700 (479kgf.cm)

### 3. Safety and leakage check

- Soap water method:  
Apply a soap water or a liquid neutral detergent on the indoor unit connections and outdoor unit connections by a soft brush to check for leakage of the connecting points of the piping. If bubbles come out, it indicates that the pipes have leakage.
- Leak detector  
Use the leak detector to check for leakage.

#### CAUTION

- A: Lo packed valve B: Hi packed valve  
C and D are ends of indoor unit connection.

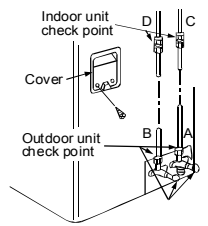

### 4. Test running

- Perform test operation after completing gas leak check at the flare nut connections and electrical safety check.
- Check that all tubing and wiring have been properly connected.
  - Check that the gas and liquid side service valves are fully open.
- Connect the power, press the ON/OFF button on the remote controller to turn the unit on.
  - Use the MODE button to select COOL, HEAT, AUTO and FAN to check if all the functions works well.
  - When the ambient temperature is too low (lower than 17°C/62°F), the unit cannot be controlled by the remote controller to run at cooling mode, manual operation can be taken. Manual operation is used only when the remote controller is disable or maintenance necessary.
    - Hold the panel sides and lift the panel up to an angle until it remains fixed with a clicking sound.
    - Press the Manual control button to select the AUTO or COOL, the unit will operate under Forced AUTO or COOL mode (see User Manual for details).
  - The test operation should last about 30 minutes.

